

**basalte**



Simplicity is the ultimate sophistication.

Leonardo Da Vinci



Home automation should be simple and add comfort to the complexity of the modern home.

Home automation systems are often designed from a technical point of view, while we believe that one should be able to control everything in an intuitive and simple way.

# TACTO

In our search for simplicity, we have created a new user experience using innovative touch sensitive technology, which makes the entire surface sensitive to touch.

As a single function switch, Tacto switches or dims lights, controls scenes and blinds at only the slightest touch without pointing to a specific area.

Touching Tacto for a longer period starts the unique scene sequencer function, which allows selecting up to four additional scenes.

The integrated multicolour LED backlight makes Tacto visible in the dark and can also be used for status feedback.

Using the integrated RGB sequencer, Tacto allows controlling RGB lights in a very simple and intuitive way.



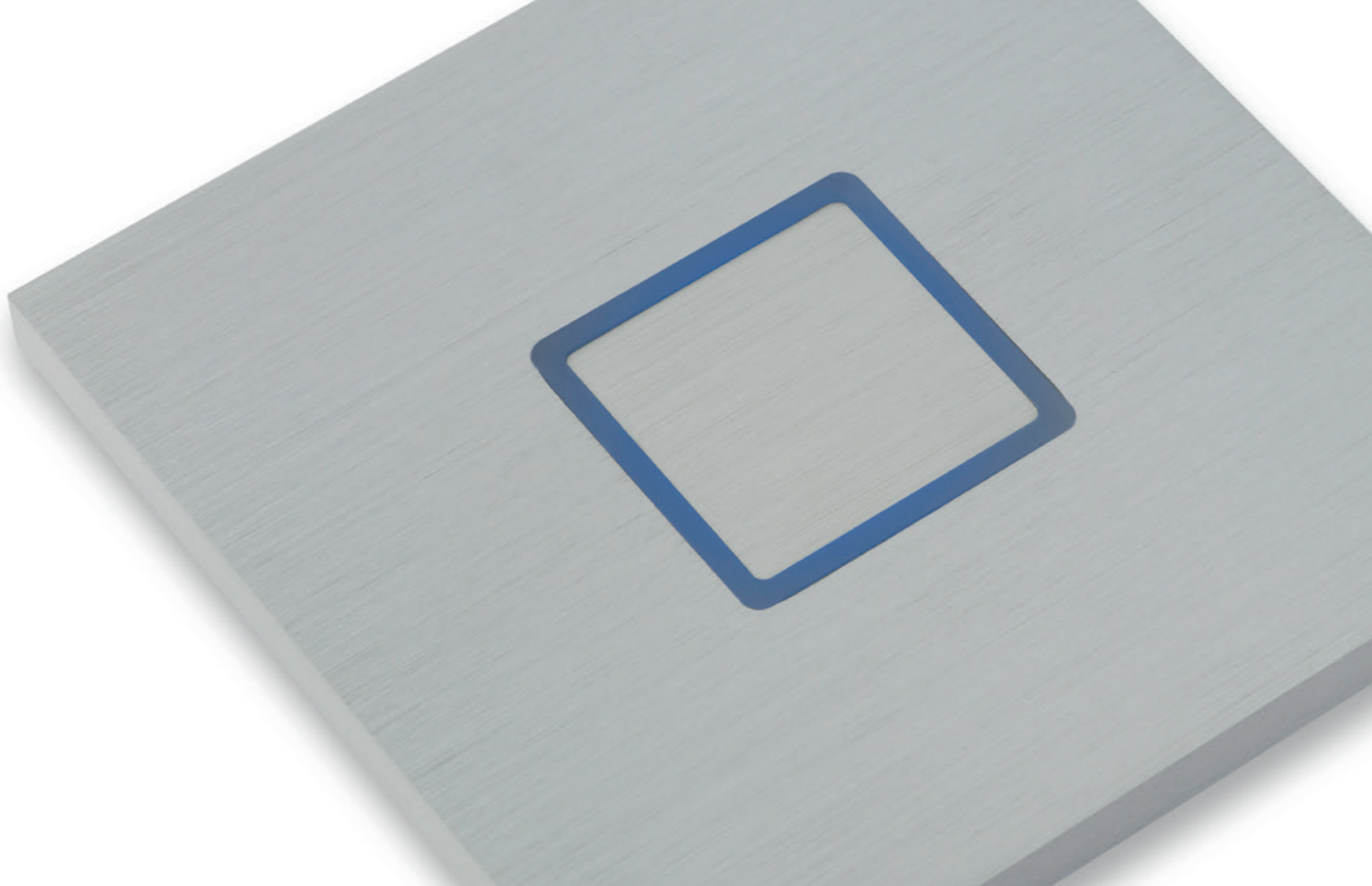





111-01 brushed aluminium

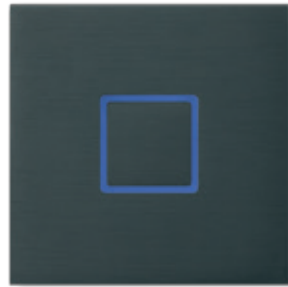

111-02 brushed dark grey

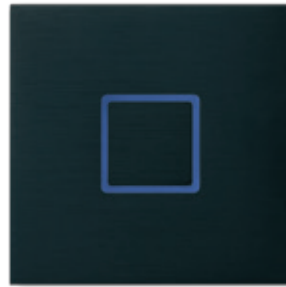

111-03 brushed black



111-04 satin white

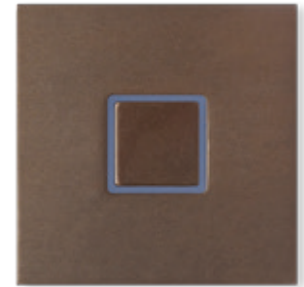

111-05 bronze

- 1 touch surface
- advanced short and long press behaviour
- integrated scene sequencer or RGB sequencer
- multicolour LED backlight
- dimensions: 80mm x 80mm x 6mm
- combined with 100-02 BCU for KNX



reddot design award  
winner 2007

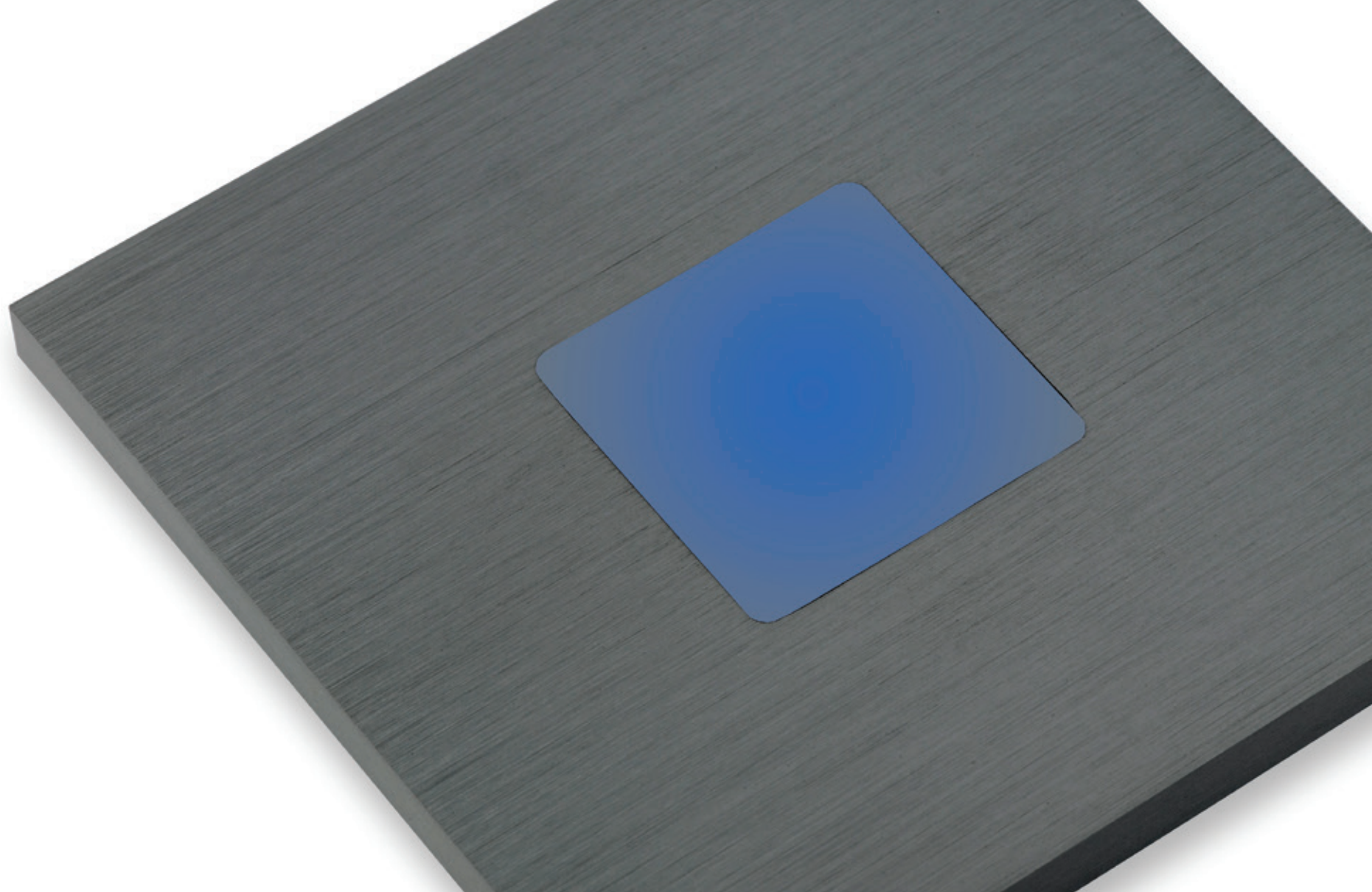



101-01 brushed aluminium

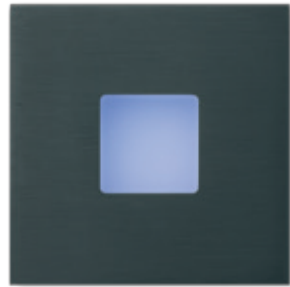

101-02 brushed dark grey

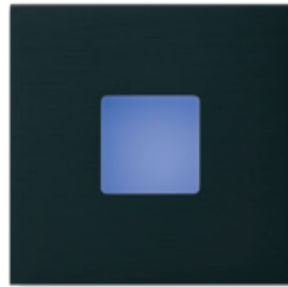

101-03 brushed black

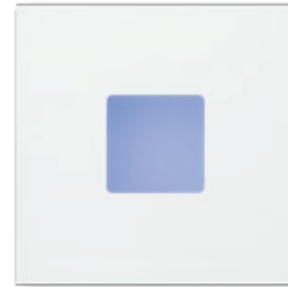

101-04 satin white

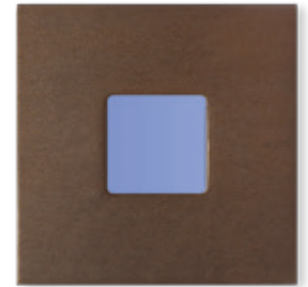

101-05 bronze

- 1 touch surface
- advanced short and long press behaviour
- integrated scene sequencer or RGB sequencer
- multicolour LED backlight
- dimensions: 80mm x 80mm x 6mm
- combined with 100-02 BCU for KNX



reddot design award  
winner 2007

# MONA

Mona is a sensually designed light switch with a finely drawn geometric stylistic language. Harmoniously it seems to melt into the wall. With its simple, architectural shape it goes with any style.

Mona features a touch-sensitive surface allowing comfortable and elegant handling, and offers the same unique functionalities as Tacto.

In switched-off position, light emitting diodes illuminate the light switch with a softly shimmering ring.





# mona



102-03 black



102-04 white



102-05 flower

- 1 touch surface
- advanced short and long press behaviour
- integrated scene sequencer or RGB sequencer
- multicolour LED backlight
- dimensions: Ø 80mm x 6mm
- combined with 100-02 BCU for KNX



reddot design award  
winner 2009

# SENTIDO

Sentido, the light switch reinvented.

The basic idea of Sentido is very simple, yet very innovative.

Divide a square in equal surfaces that each control different functions. The entire surface is touch-sensitive, creating a very easy and unique way of control.

Touching more than one surface at the same time turns on and off all the lights in a room using a general scene. This multi-touch function makes light control highly intuitive and user friendly.

Touching multi-touch for a longer period starts the unique scene sequencer function, which allows selecting up to four additional scenes.

The internal temperature sensor discretely reports the room temperature to the home automation system while the integrated thermostat logic controls the heating and air-conditioning of the room.

The multicolour LED backlight can be used for status feedback or simply to light up Sentido in the dark.

Using the integrated RGB sequencer in combination with multi-touch allows controlling RGB lights in a very simple and intuitive way.



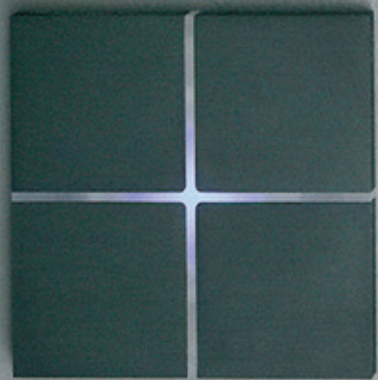





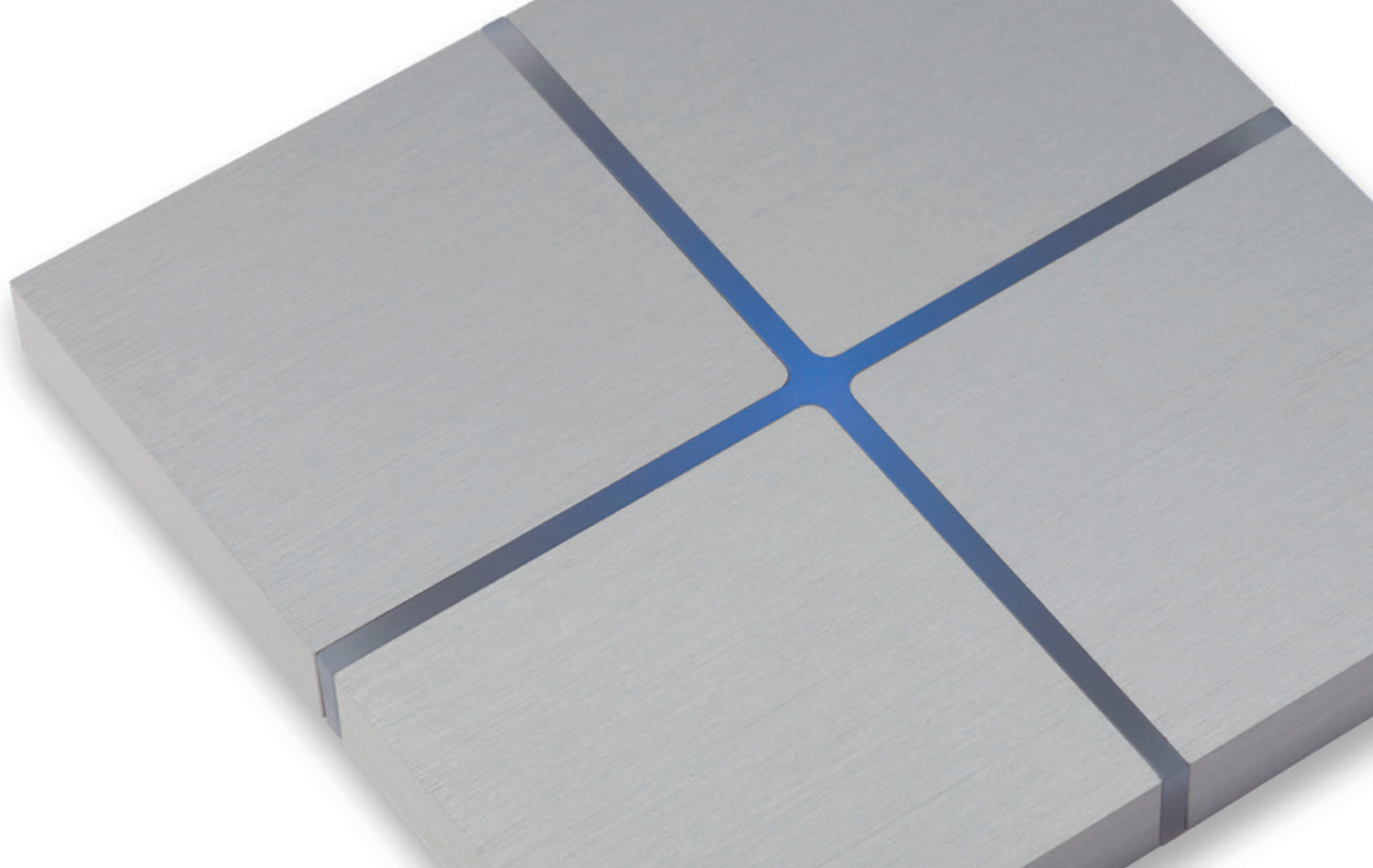

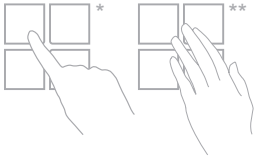

# sentido

4-way aluminium



202-01 brushed aluminium

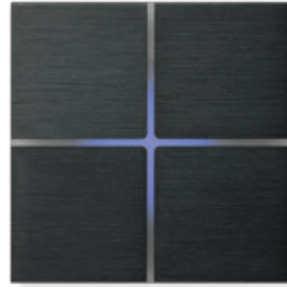

202-02 brushed dark grey



202-03 brushed black



202-04 satin white

- 4 single touch surfaces \*
- 1 multi-touch \*\*
- integrated scene sequencer or RGB sequencer
- multicolour LED backlight
- temperature sensor with integrated thermostat logic
- dimensions: 80mm x 80mm x 8mm
- combined with 200-02 BCU for KNX

DESIGN PLUS  
2008



reddot design award  
winner 2008

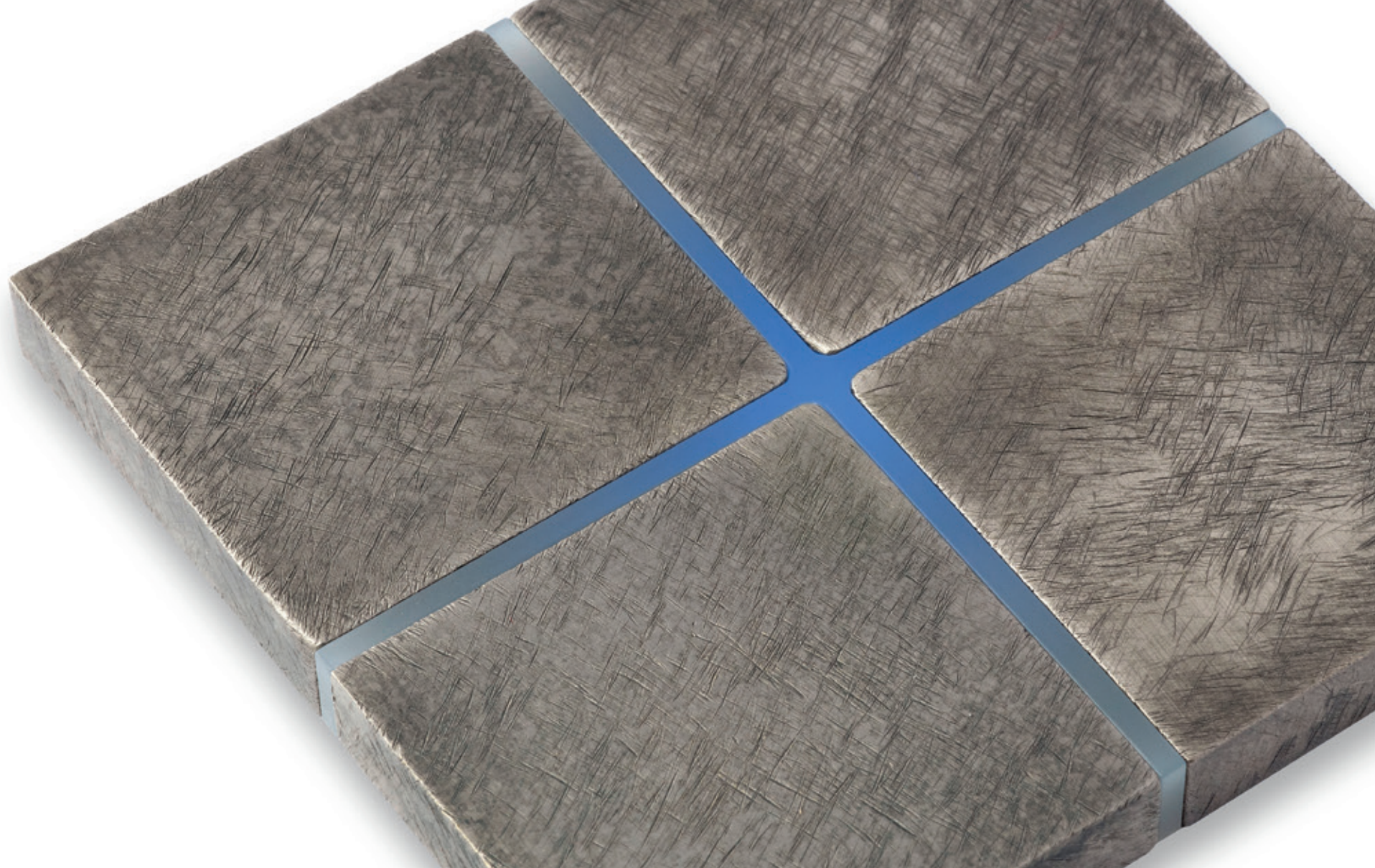

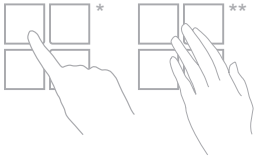

# sentido

## 4-way classic

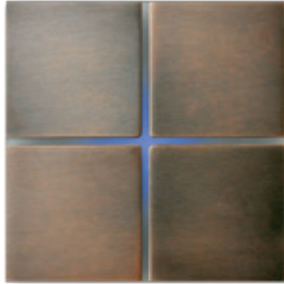

202-05 bronze

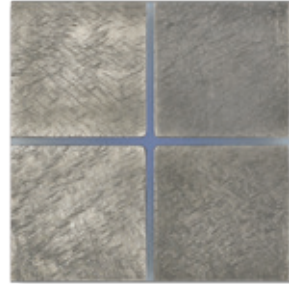

202-06 fer forgé



202-07 brushed nickel



202-08 brushed brass

- 4 single touch surfaces \*
- 1 multi-touch \*\*
- integrated scene sequencer or RGB sequencer
- multicolour LED backlight
- temperature sensor with integrated thermostat logic
- dimensions: 80mm x 80mm x 8mm
- combined with 200-02 BCU for KNX

DESIGN PLUS  
2008



reddot design award  
winner 2008

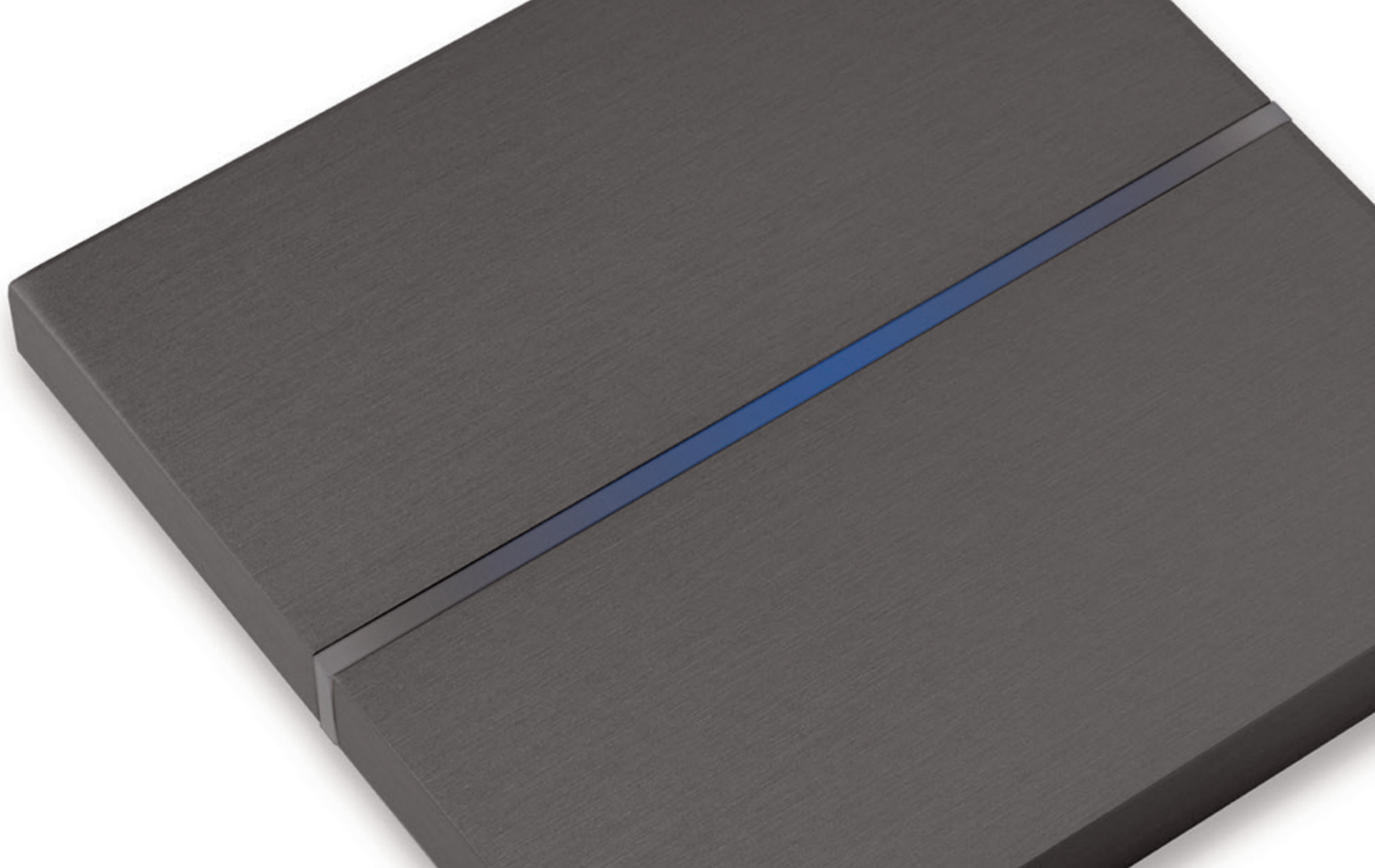



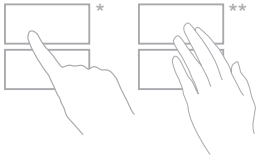

# sentido

## 2-way aluminium



201-01 brushed aluminium



201-02 brushed dark grey



201-03 brushed black



201-04 satin white

- 2 single touch surfaces \*
- 1 multi-touch \*\*
- integrated scene sequencer or RGB sequencer
- multicolour LED backlight
- temperature sensor with integrated thermostat logic
- dimensions: 80mm x 80mm x 8mm
- combined with 200-02 BCU for KNX

DESIGN PLUS  
2008



reddot design award  
winner 2008

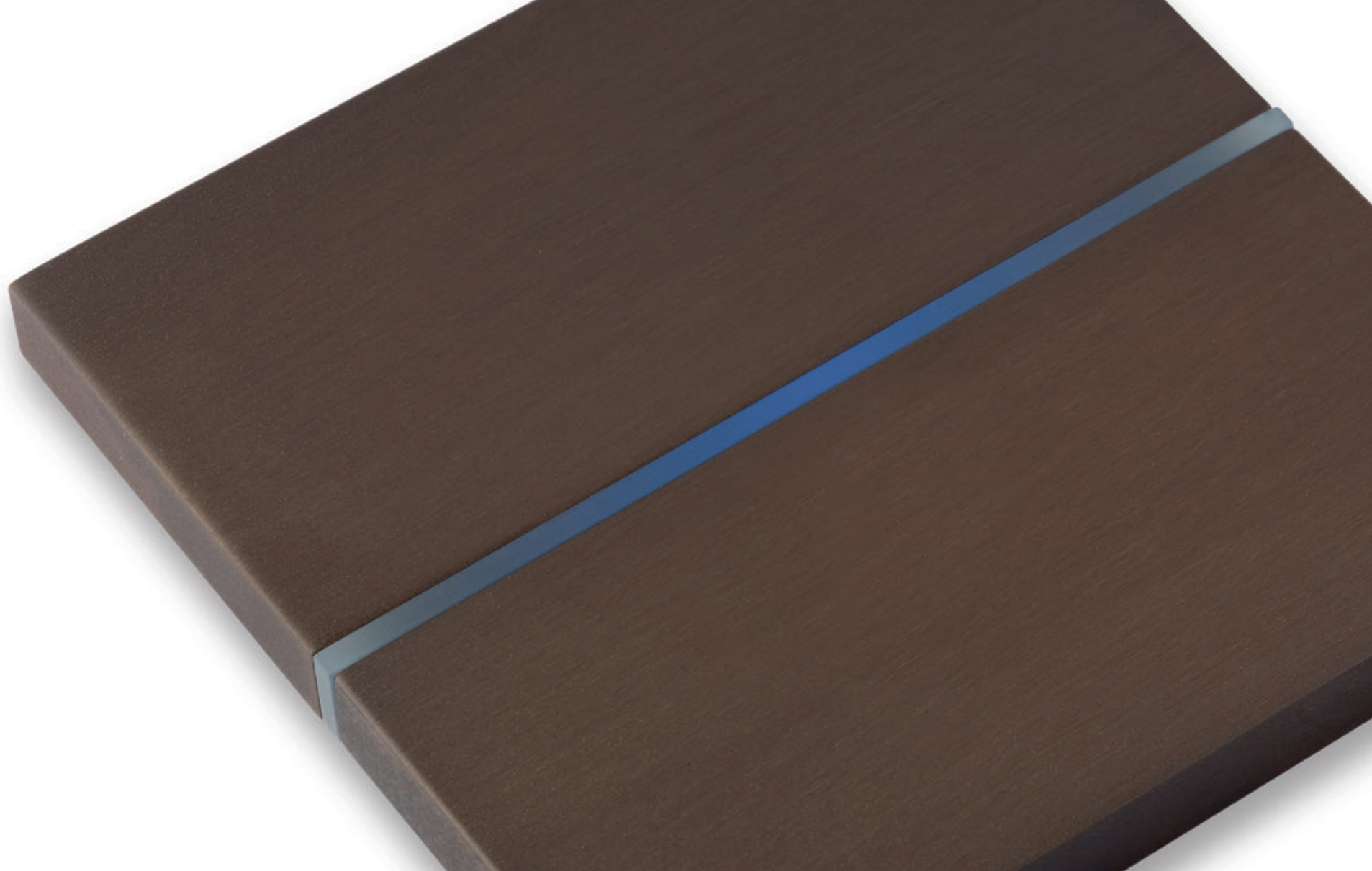

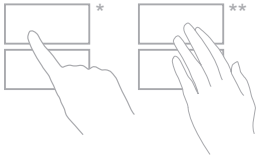

# sentido

## 2-way classic



201-05 bronze

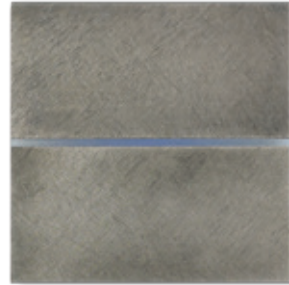

201-06 fer forgé



201-07 brushed nickel

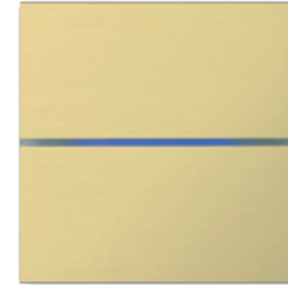

201-08 brushed brass

- 2 single touch surfaces \*
- 1 multi-touch \*\*
- integrated scene sequencer or RGB sequencer
- multicolour LED backlight
- temperature sensor with integrated thermostat logic
- dimensions: 80mm x 80mm x 8mm
- combined with 200-02 BCU for KNX

DESIGN PLUS  
2008



reddot design award  
winner 2008

# ENZO

Inspired by Italian design of the late fifties, Enzo combines retro with luxury based on craftsmanship and high quality materials.

The fine rounded border is made of polished aluminium while the inlay can be leather or glass.

Despite its retro look, Enzo uses the latest technology and features highly sensitive touch sensors, multi-touch capability and temperature control.

Enzo offers the same unique and innovative functionalities as Sentido.

The integrated multicolour LED backlight makes Enzo visible in the dark and can also be used for status feedback.



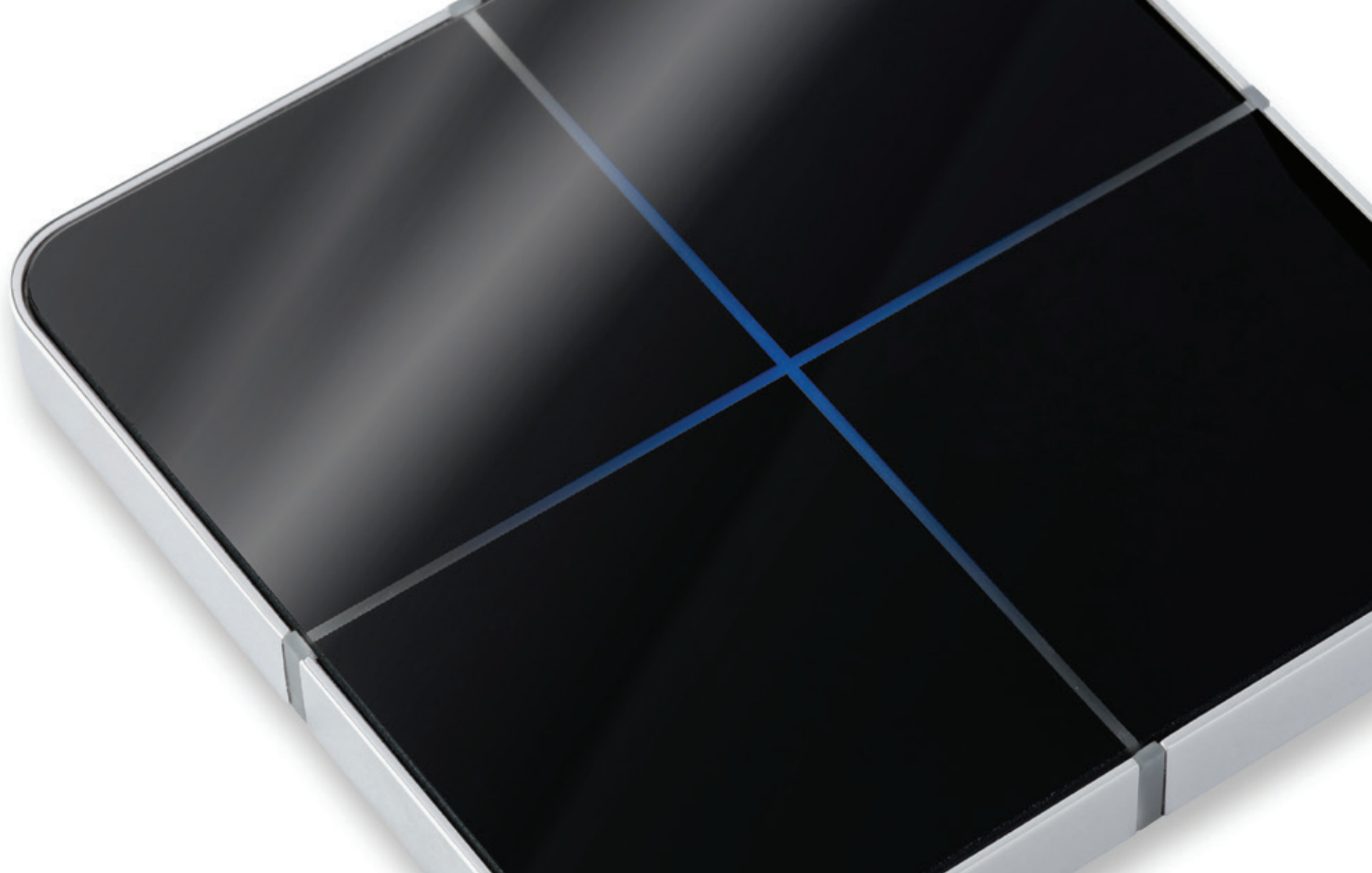

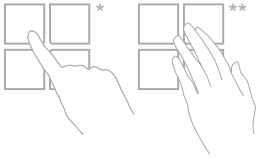

# enzo

4-way

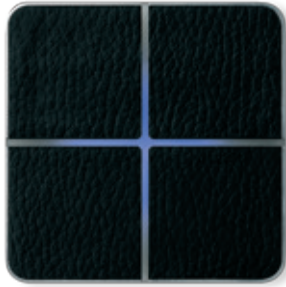

204-13 black leather



204-14 white leather



204-03 black glass



204-04 white glass

- 4 single touch surfaces \*
- 1 multi-touch \*\*
- integrated scene sequencer or RGB sequencer
- multicolour LED backlight
- temperature sensor with integrated thermostat logic
- dimensions: 80mm x 80mm x 8mm
- combined with 200-02 BCU for KNX



best of  
**DESIGN PLUS**  
2010



reddot design award  
winner 2010





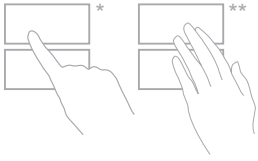

enzo  
2-way



203-13 black leather



203-14 white leather



203-03 black glass



203-04 white glass

- 2 single touch surfaces \*
- 1 multi-touch \*\*
- integrated scene sequencer or RGB sequencer
- multicolour LED backlight
- temperature sensor with integrated thermostat logic
- dimensions: 80mm x 80mm x 8mm
- combined with 200-02 BCU for KNX



Designpreis  
Deutschland  
2010  
NOMINEE

best of  
**DESIGN PLUS**  
2010



reddot design award  
winner 2010

# D E S E O

At first look, Deseo is a beautiful intelligent thermostat. But in fact, Deseo is much more than just a thermostat.

Discrete and minimalistic, Deseo offers a simple and innovative user interface. Highly sensitive touch sensors allow you to navigate through all the functions in a room. Lights, scenes, shutters and blinds, even the multi-room audio system can be controlled at the slightest touch.

We call it; a room controller.

This innovative concept allows light switches in a room to remain simple and to control only the most important functionalities. All other, less important functions can be controlled with Deseo.

And as Sentido, a simple multi-touch will start a welcome or goodbye scene.

Deseo, because we like to keep things simple.



bureau  
24.0°C

A close-up, angled view of a white rectangular digital display. The display is illuminated with a black background, and the time and temperature are shown in a bright blue, seven-segment font. The time is 15:35 and the temperature is 20.6°C.

15:35

20.6°C

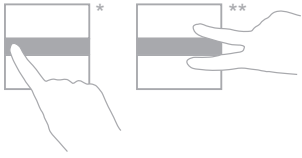

# deseo

room controller aluminium



301-01 brushed aluminium



301-02 brushed dark grey



301-03 brushed black

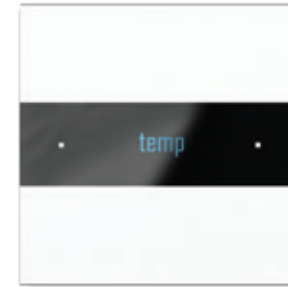

301-04 satin white

- touch controlled menu \*
- 1 multi-touch \*\*
- 1.7" oled display
- temperature sensor with integrated thermostat logic
- dimensions: 80mm x 80mm x 8mm
- combined with 300-02 BCU for KNX



reddot design award  
winner 2011



15:35  
20.6°C

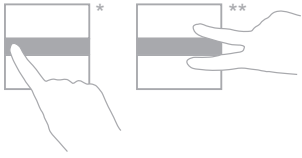

# deseo

room controller classic



301-05 bronze



301-06 fer forgé



301-07 brushed nickel



301-08 brushed brass

- touch controlled menu \*
- 1 multi-touch \*\*
- 1.7" oled display
- temperature sensor with integrated thermostat logic
- dimensions: 80mm x 80mm x 8mm
- combined with 300-02 BCU for KNX



reddot design award  
winner 2011



15:35  
20.6°C



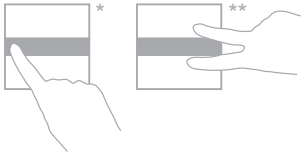

# deseo

room controller retro



301-13 black leather



301-14 white leather



301-23 black glass



301-24 white glass

- touch controlled menu \*
- 1 multi-touch \*\*
- 1.7" oled display
- temperature sensor with integrated thermostat logic
- dimensions: 80mm x 80mm x 8mm
- combined with 300-02 BCU for KNX



reddot design award  
winner 2011

# AURO

Auro is everything what a motion detector should be, small, fast and almost invisible. When mounted in the ceiling, the innovative flat design makes Auro completely blend in. Only requiring an opening of 43mm, it is very easy to install.

Auro has a built in light sensor for light dependent switching, dimming and controlling scenes and can even behave differently during day or night.

The internal temperature sensor discretely reports the room temperature to the home automation system while it can also be used to trigger a heat alarm in case of a fire.

With a vertical detection angle of 90° it has a detection area with a diameter of 5m when installed at a height of 2.5m, making it perfect for hallways, toilets and small rooms.





# auro

motion detector



180-02 white



180-03 black

- completely flat design
- visible diameter 52mm
- visible thickness 1mm
- 360° range horizontal
- 90° range vertical
- integrated LED feedback
- integrated lux sensor (only white version)
- integrated temperature sensor
- available in white and black

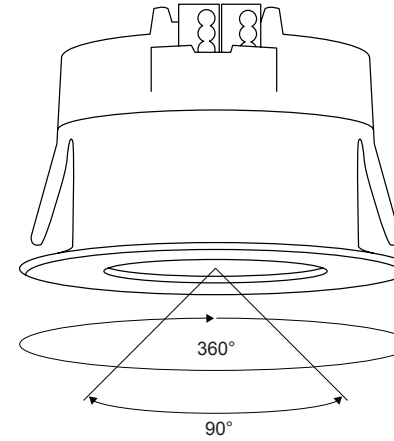
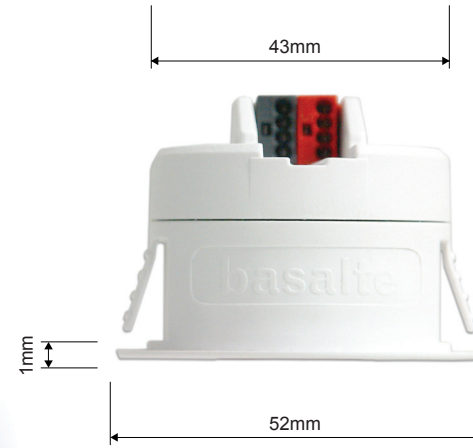

actual size

# FRAME

To complement our products with sockets and outlets, we have designed frames with the same finishing as our switches.

These frames can be used in combination with 55mm inserts from all major manufacturers.  
The frames are available in 1, 2, 3, 4 and 5-gang.







# frame

for 55mm insert  
aluminium



brushed aluminium

001-01 1-gang  
002-01 2-gang  
003-01 3-gang  
004-01 4-gang  
005-01 5-gang



brushed dark grey

001-02 1-gang  
002-02 2-gang  
003-02 3-gang  
004-02 4-gang  
005-02 5-gang



brushed black

001-03 1-gang  
002-03 2-gang  
003-03 3-gang  
004-03 4-gang  
005-03 5-gang



satin white

001-04 1-gang  
002-04 2-gang  
003-04 3-gang  
004-04 4-gang  
005-04 5-gang

- dimensions: 1-gang: 80mm x 80mm x 9mm  
2-gang: 151mm x 80mm x 9mm  
3-gang: 222mm x 80mm x 9mm  
4-gang: 293mm x 80mm x 9mm  
5-gang: 364mm x 80mm x 9mm

- combine with 55-mm insert for sockets and outlets from Schneider/Merten, Gira and Jung



# frame

for 55mm insert  
classic



bronze

001-05 1-gang  
002-05 2-gang  
003-05 3-gang  
004-05 4-gang  
005-05 5-gang



fer forgé

001-06 1-gang  
002-06 2-gang  
003-06 3-gang  
004-06 4-gang  
005-06 5-gang



brushed nickel

001-07 1-gang  
002-07 2-gang  
003-07 3-gang  
004-07 4-gang  
005-07 5-gang



brushed brass

001-08 1-gang  
002-08 2-gang  
003-08 3-gang  
004-08 4-gang  
005-08 5-gang

- dimensions: 1-gang: 80mm x 80mm x 9mm  
2-gang: 151mm x 80mm x 9mm  
3-gang: 222mm x 80mm x 9mm  
4-gang: 293mm x 80mm x 9mm  
5-gang: 364mm x 80mm x 9mm

- combine with 55-mm insert for sockets and outlets from Schneider/Merten, Gira and Jung



Design is not just what it looks like and feels like.  
Design is how it works.

Steve Jobs

# technical specifications

specifications may alter without prior notice

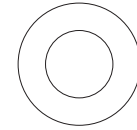
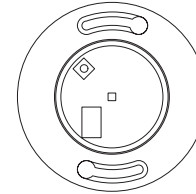
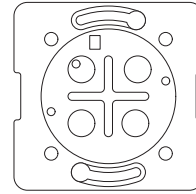
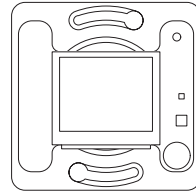

KNX

KNX

KNX

KNX

name / productnumber	deseo KNX / 300-02	sentido KNX / 200-02	tacto KNX / 100-02	auro KNX / 180-02/180-03
front cover	deseo	sentido and enzo	tacto and mona	-
interface	KNX integrated BCU	KNX integrated BCU	KNX integrated BCU	KNX integrated BCU
display	1.7" Oled	-	-	-
multi-touch	yes	yes	-	-
scene- and RGB sequencer	-	yes	yes	-
multicolour LED	-	integrated	integrated	white led integrated
temperature sensor	integrated	integrated	-	integrated
thermostat logic	integrated	integrated	-	-
lux sensor	-	-	-	integrated (only 180-02)
power supply	15 - 30V DC separate from KNX bus	KNX buspower	KNX buspower	KNX buspower
power consumption	1W	10mA	10mA	10mA
dimensions	70mm x 70mm x 30mm	70mm x 70mm x 25mm	diam: 74mm x 32mm	diam: 52mm x 39mm
backbox	European standard box with screws 60mm	European standard box with screws 60mm	European standard box with screws 60mm	cutout diam: 43mm
certification	CE	CE	CE	CE







Who ever said that pleasure wasn't functional?

Charles Eames

# basalte

hundelgemsesteenweg 1a

9820 merelbeke

belgium

info@basalte.be

[www.basalte.be](http://www.basalte.be)

© basalte 2014

basalte is a registered trademark of basalte bvba

Pictures shown are indicative only. The actual finishes can have a different surface aspect.

with the support of Flanders **Investment & Trade**  
Gouvernement of Flanders - Belgium



[www.basalte.be](http://www.basalte.be)